

PETONEER
湃妮

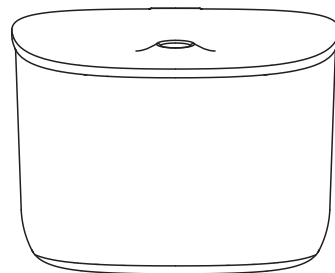

Fresco EzGo
User Manual

宠物饮水机EzGo
使用说明书

Model / 型号: WF005

Please read this manual carefully before using.
Keep the manual in a safe place for future reference.
使用产品前请仔细阅读本使用说明书并妥善保管

www.petoneer.com

01 / Inside the box



Fountain*1



Base*1



Filter*1



Foam*1



Manual*1

02 / Meet your smart fountain

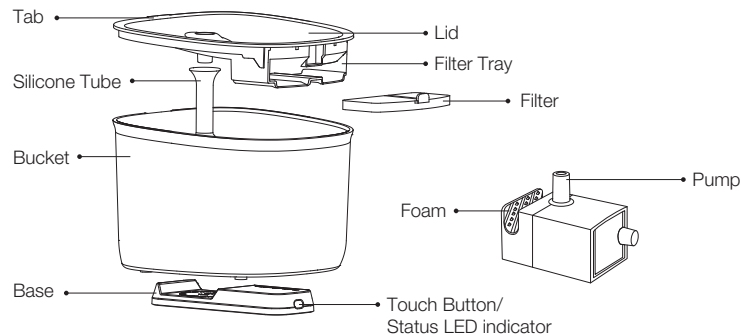

03 / Operations

① Clean up

The bucket, lid, and filter tray are washable.

Wipe or dry the surface of the bucket before use.

*Do not wash the base.

*Rinse and soak the filter in clean water for 5 minutes.

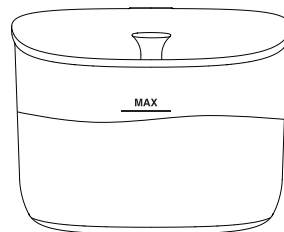
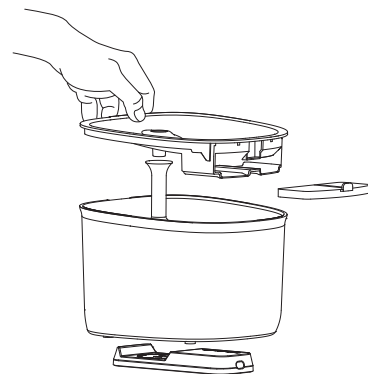

② Fill up

When pouring, ensure the water does not exceed the maximum water level line.

③ Assemble

Assemble the filter tray, filter and lid according to the illustration and put them in the bucket.

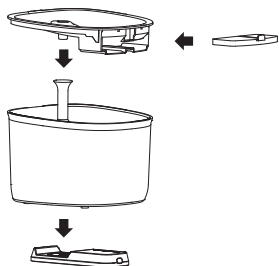

⑤ Accessories replacing

It is recommended to replace the filter and foam every 30 days.

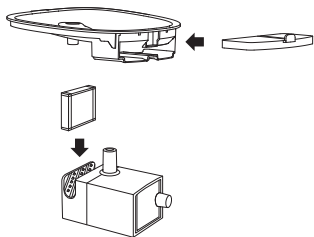

④ Power on

Connect the cable to the power adaptor, then plug it into the wall outlet.

*The adaptor (USB 5V 1A) is not included; please find a spare one.

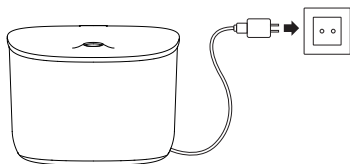

⑥ Connect the fountain

Download the Petoneer app and connect the fountain to your Wi-Fi to monitor and control.

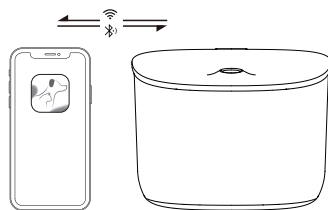

04 / Quick Setup

1 Scan the QR code on the right and download the Petoneer App which is available on App Store and Google Play. Click Sign up to get walked through to create your Petoneer account.



2 Power on and ensure the Wi-Fi Indicator LED is blinking fast reflecting the device is ready for joining the Wi-Fi.

Open the Petoneer App and click the '+' button and get walked through the SET-UP steps.

Notice:

- 1) The fountain doesn't support the 5GHz Wi-Fi, please make sure your Wi-Fi is 2.4G.
- 2) If the Wi-Fi indicator is not blinking fast after power-on, please long press and hold the manual feed button until the indicator blinks quickly.

05 / Status Indicator Explained

Status Indicator LED	Meaning
Wi-Fi indicator steady blue	Connected
Wi-Fi indicator blinks in blue	Disconnected
Steady red	Low water/ no water
Blinks in red	Filter Expired

06 / Specifications

Description: Fresco EzGo

Model No.: WF005

Dimension: 195*192*140mm

Material: ABS

Input Voltage: 5V = 1A

Capacity: 2.0L

Warranty: 1 year

Weight: 20.74 oz(588g)

07 / Precautions

1. Use the product in the indoor environment.
2. Place the product on the level of the ground to avoid it tipping over, spilling and improperly operating
3. Disconnect the power supply when cleaning the whole machine or changing the water.
4. Clean the base with a dry cloth and do not soak it.
5. Keep the charging surface clear of any metal or foreign objects!
6. Please shield or organize the power cord well to prevent the pet from biting it.
7. Low water reminder does not work if the fountain is not working. When there is water by default and the fountain is working, it will alert when water is detected low.
8. This fountain is suitable for cats or small and medium-size dogs.

08 / Warranty Terms

Within the period of warranty, if the product fails with no fault of user operations, it will be repaired at Petoneer's expense. Repairs resulting from the following conditions are not included in the warranty terms.

- 1) Damage caused by intentional actions.
- 2) Failure by not in accordance with the (QIG) Quick Installation Guide Instruction for the use and maintenance of the product.

3) Failure by natural wear and tear including but not limited to scratching, corrosion, oxidation and rusting.

4) Failure by repair, modification or cleaning at a non-Petoneer authorized third party or by the user's own.

(In order to provide better products, we make regular product improvements. All Pictures shown in the manual are for illustration purpose only. Actual product may vary due to product enhancement.)

Manufacturer: SkyRC Technology Co. Ltd.

Address: Floor 4,5,8, Building 4, Meitai Industrial Park, Guanguang Road, Guanlan, Longhua District, Shenzhen, China, 518110.

FCC Note

This device complies with part 15 of the FCC Rules. Operation is subject to the following two conditions: (1) This device may not cause harmful interference, and (2) this device must accept any interference received, including interference that may cause undesired operation.

Note: The Grantee is not responsible for any changes or modifications not expressly approved by the party responsible for compliance. such modifications could void the user's authority to operate the equipment.

Note: This equipment has been tested and found to comply with the limits for a Class B digital device, pursuant to part 15 of the FCC Rules. These limits are designed to provide reasonable protection against harmful interference in a residential installation. This equipment generates, uses and can radiate radio frequency energy and, if not installed and used in accordance with the instructions, may cause harmful interference to radio communications.

However, there is no guarantee that interference will not occur in a particular installation. If this equipment does cause harmful interference to radio or television reception, which can be determined by turning the equipment off and on, the user is encouraged to try to correct the interference by one or more of the following measures:

- Reorient or relocate the receiving antenna.
- Increase the separation between the equipment and receiver.
- Connect the equipment into an outlet on a circuit different from that to which the receiver is connected.
- Consult the dealer or an experienced radio/TV technician for help.

FCC Radiation Exposure Statement

The equipment complies with FCC Radiation exposure limits set forth for uncontrolled environment.

This equipment should be installed and operated with minimum distance 20cm between the radiator and your body.

Environmental Conditions

Operating Temperature: 32 °F to 104 °F, (0 °C to 40 °C) (indoor only).

SkyRC Technology Co., Ltd. declares that this Fresco EzGo (WF005), is in compliance with the essential requirements and other relevant provisions of the Radio Equipment Directive (2014/53/EU).

Environment friendly disposal

You can help protect the environment!

Please remember to respect your local regulations: dispose of nonfunctional electrical equipment with an appropriate waste disposal center.



09 / Read all the instructions

When using electrical appliances, basic safety precautions should always be followed, including the following:

1. Do not touch hot surfaces. Use handles.
2. To protect against electric shock do not immerse cord, plug into water or other liquid.
3. Close supervision is necessary when any appliance is used by or near children.
4. Unplug from outlet when not in use and before cleaning. Allow to cool before putting on or taking off parts, and before cleaning the appliance.
5. Do not operate any appliance with a damaged cord or plug, should the appliance malfunction, or if it has been damaged in any manner. Return appliance to the nearest authorized service facility for examination, repair or adjustment.
6. The use of the accessory attachments is not recommended by the appliance manufacturer as it may cause injuries.
7. Do not use outdoors.
8. Do not let the cord hang over edge of table or counter, or touch hot surfaces.
9. Do not place on or near a hot gas or electric burner, or in a heated oven.
10. Always attach plug to appliance first, then plug cord in the wall outlet.
11. Do not use the appliance for other than intended use.
12. WARNING: Never leave the appliance unattended whilst in use.

13. Warning: keep the supply cord away from heating tip and metal enclosure while using.

14. This appliance is not intended for use by persons (including children) with reduced.

physical, sensory or mental capabilities, or lack of experience and knowledge, unless they have been given supervision or instructions concerning use of the appliance by a person responsible for their safety.

15. Children should be supervised to ensure that they do not play with the appliance.

16. If the SUPPLY CORD is damaged, it must be replaced by the manufacturer, its service agent or similarly qualified persons in order to avoid a hazard.

17. WARNING: This tool must be placed on its stand when not in use.

SAVE THESE INSTRUCTIONS.

Manufacturer: SkyRC Technology Co., Ltd.

Address: Floors 4, 5, & 8, Building 4, Meitai Technology Park, Guanguang South Road, Guanlan, Longhua District, Shenzhen, China

01 / 包装清单



饮水机 x 1



主机底座 x 1



滤芯 x 1



海绵 x 1



说明书 x 1

02 / 产品概览

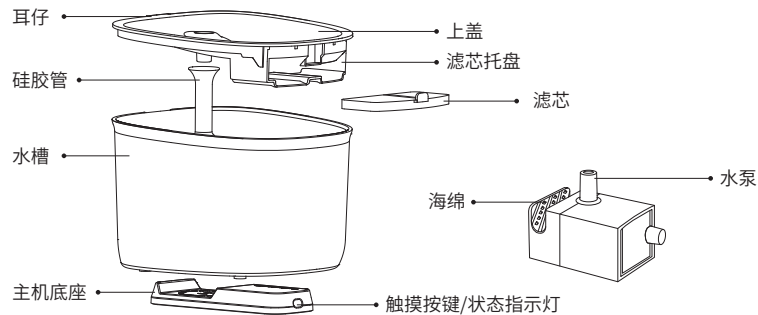

03 / 使用步骤

① 清洗

水槽、上盖和滤芯托盘可水洗。
水槽外壳请擦拭或晾干后使用。
*请勿清洗主机底座。
*滤芯冲洗后用清水浸泡5分钟。

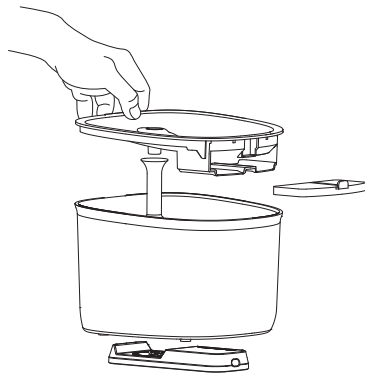

② 加水

将水倒入水槽中，加水量不要超过最高水位线。

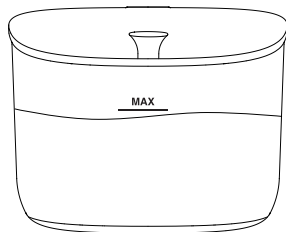

③ 组装

将滤芯托盘、滤芯、上盖依次组装后放入水槽中。

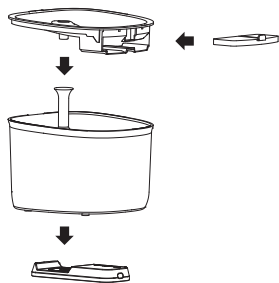

⑤ 更换耗材

建议每30天更换一次滤芯和海绵。

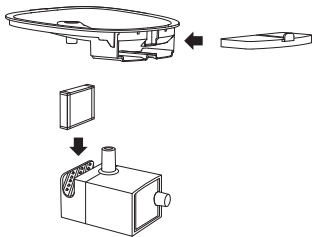

④ 连接电源

将水机电源线与适配器连接，并接通电源。

*本产品不提供电源适配器（USB 5V 1A），请自行配置。

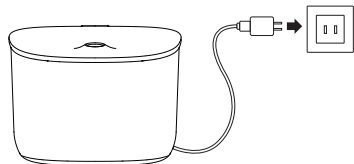

⑥ 添加设备

下载“Petoneer” APP，添加设备，实时掌控水机状态。

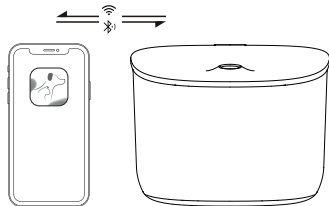

04 / 快速添加设备

1.扫描右侧二维码，或前往“GooglePlay”与“AppStore”下载安装“Petoneer” APP，并注册登录账号。



2.通电后，Wi-Fi指示灯快闪，进入配置模式。

请打开“Petoneer” APP,点击“+”按照提示进行设置。

注意：

- (1) 饮水机不支持5GHz路由器，请使用2.4GHz路由器
- (2) 若通电开机后Wi-Fi指示灯处于不在快闪状态，请长按按键，直至指示灯快闪。

05 / 状态指示灯说明

指示灯	描述
Wi-Fi指示灯蓝灯常亮	Wi-Fi已连接
Wi-Fi指示灯蓝灯闪烁	网络断开
状态指示灯红灯常亮	少水/缺水
状态指示灯红灯闪烁	滤芯到期

06 / 基本参数

产品品名：宠物饮水机EzGo

产品型号：WF005

产品尺寸：195*192*140mm

产品材质：ABS

执行标准：Q/TK 001-2019

电源供电：DC 5V \pm 1A

储水容量：2.0L

保修期：1年

产品净重：588g

07 / 注意事项

- 1.请在室内环境使用。
- 2.请放置在水平地面上，以防不慎打翻，导致设备洒水不正常工作。
- 3.进行整机清理或换水时，请断开电源。
- 4.本产品主机底座请用干燥抹布进行清理，请勿浸泡水中。
- 5.无线充电区域请勿放置金属部件或其它异物！
- 6.请做好电源线遮挡或收纳，以防宠物撕咬电线。
- 7.缺水提醒在水机不工作时不检测不提醒，默认有水，工作时检测到缺水则提醒。
- 8.本机适用于猫或中小型犬。

08 / 保修条款

在保修期限内，对于正常使用Petoneer产品过程中，由于非人为导致的损坏，所产生的维修费用和 Related 的人工费用，由Petoneer承担。以下情况导致的维修不在保修条款包含中。。

- (1) 故意行为导致的损坏。
- (2) 未按照产品使用说明书指引使用、保养该产品。
- (3) 设备正常磨损、腐蚀、氧化、锈垢、耗损等原因导致的损失。
- (4) 因在非Petoneer授权维修代理店或用户自身进行维修、改造、清洗而造成的损坏。
(为了更好的产品，我们会定期进行产品改良。产品实物可能与说明书有差异。)

制造商：天空创新科技(深圳)有限公司

地址：深圳市龙华区观澜街道桂花社区观光路美泰科技园4栋4, 5, 8层

