

Smart Air Purifier
User Manual

Please read this manual carefully before using.Keep the manual in a safe place for future reference.

01 / Meet Your Smart Air Purifier

Inside the Box

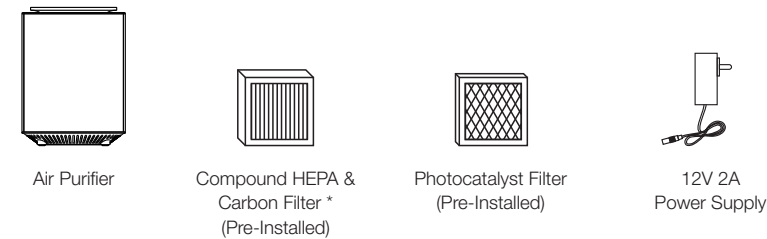

Get to Know AirMaster

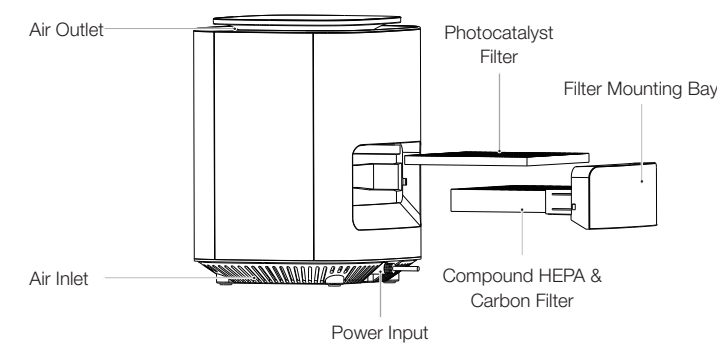

* Compound HEPA & Carbon Filter is composed of HEPA Filter and Activated Carbon Filter.

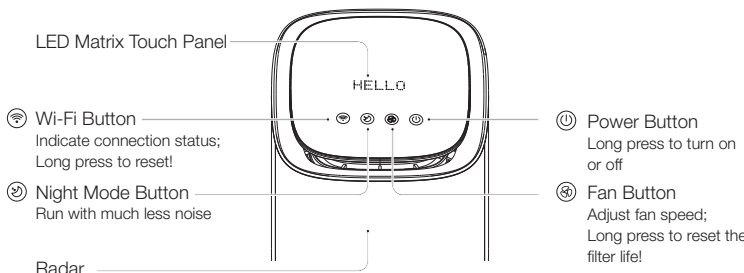

Surveillance Range by the Radar
Optimized range by the radar

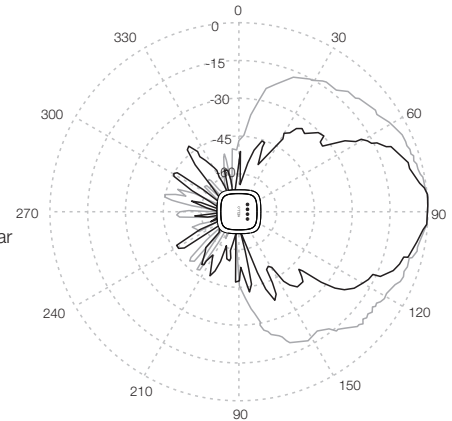

02 / How it Works

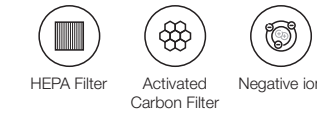

Purifies the Air
Compound HEPA & Carbon Filter captures 99% of dust, pollen, pet dander and odors. An ionizer producing negative ions in an environment quickly reduced airborne dust.

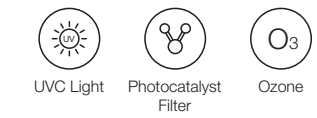

Destroys Germs & Bacteria
The UV-C light is purifying the inside of the purifier and killing germs and molds trapped in the compound filters. Photocatalytic Filter breaks down volatile organic compounds (VOCs), or odors in gas form, into carbon dioxide and water. Ozone generated by AirMaster will kill mold and remove any odor with ozone oxidation.

03 / Operations

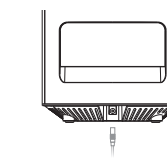

- Connect the Power**
Unbox and connect the power supply to the purifier, then connect A/C adapter to the wall outlet.

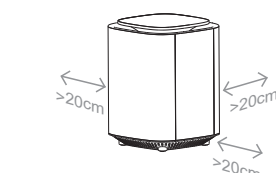

- Positioning**
Ensure the air filter is properly positioned in the purifier. Allow enough clearance on all sides of the purifier for best performance.

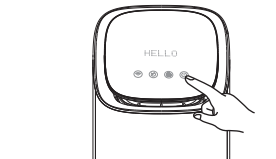

- Power On**
Long press to turn on.

04 / Quick Setup & Factory Reset

Quick Setup



- Scan the QR code on the right and download the Petoneer App, which is available on App Store and Google Play. Click Sign up to get walked through to create your Petoneer account.
- Power on and ensure the Wi-Fi Indicator button is blinking fast, reflecting the device is ready for joining the Wi-Fi. Open the Petoneer App and click the '+' button and get walked through the SET-UP steps.

Notice:
(1). The device doesn't support the 5GHz Wi-Fi, please make sure your Wi-Fi is 2.4G.
(2). If the Wi-Fi indicator is not blinking fast after power-on, please long press and hold the Wi-Fi button until the indicator blinks quickly.

Factory Reset

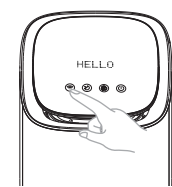

Long press Wi-Fi button for 5 seconds until it blinks fast, reflecting it has been restored to factory setting!

05 / Work Modes



Fresh Mode
Run with photocatalyst filter, Negative ion, UV-C working, and fan at adjustable levels(default: level 3).



Night Mode
Run only with photocatalyst filter working and fan at level 1.



Away Mode(60 minutes)
Run with photocatalyst filter, Negative ion, UV-C, Ozone emits (30 minutes), and fan at level 5.



Safety Lock
The safety locks prevent children or pets from accidental touching.

06 / AWAY Mode

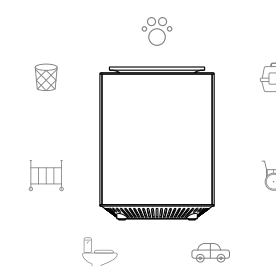

The AWAY mode is used where strong deodorization is required. In the mode, in addition to the full working of the photocatalyst, the purifier also actively emit ozone. The mode works for 1 hour, and ozone is emitted for half an hour. The purifier will return to FRESH mode after 1 hour.



Sterilizing



Disinfection



Odor-eliminating



No Secondary Pollution



Radar Detector

***Ozone**
Ozone is widely found in nature and is a layer to protect our earth. Ozone has a strong ability to kill odors, bacteria, etc., and ozone disinfection can be spread throughout the space in a short time without hindrance or dead corners. Ozone is an unstable molecule and over time will decompose into O₂ and a free Oxygen.Excessive ozone is irritating to the respiratory tract of humans and animals. To avoid harm, ensure people or animals leave the space before you initiate the AWAY mode. Only Re-enter the area in one hour after the App counts down. Additionally, the purifier has an integrated high-sensitivity radar detector. In AWAY mode, when the radar detects that an object is moving nearby, the purifier immediately stops emitting ozone and switches to FRESH mode.

07 / Maintaining

Replacing the Compound HEPA & Carbon Filter

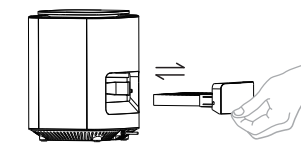

CLEAN FILTER

AirMaster will remind you to clean the Compound HEPA & Carbon Filter every other month. Please clean or replace the new filter as appropriate.
* Replacing filter every 3 months is recommended!



RESET...DONE!

After cleaning or replacing the filter, please press and hold the "Ⓜ" icon until RESET ... DONE! appears on the display or operate the filter resetting on the APP.
* Make sure the filter is reset; otherwise, the filter life cannot be calculated.

Replacing the Photocatalyst Filter

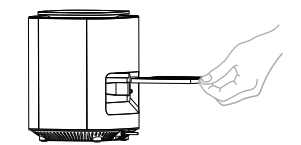

As photocatalytic activity will decrease significantly after one year, the APP will remind you to replace after one year. Please contact your seller to purchase and replace.

Cleaning the AirMaster

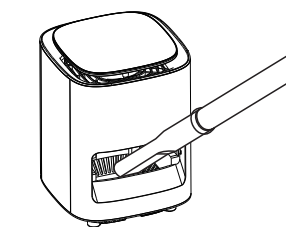

For better ventilation and purifying, use a vacuum cleaner or gently wipe with a soft cloth.

Notice: Be sure to power off the purifier before performing the above operations.

08 / Specification

Model: AOE020
Coverage: 5-10m² (54-108sq.ft)
Size: 180x180x240mm
(7.08x7.08x9.46in)
Manufacturer: SkyRC Technology Co., Ltd.

Power Input: 12V/ 2A
Communcation: Wi-Fi (2.4GHz)
Net Weight: 1450g (51.15oz)

09 / Precautions

- Please use it in the indoor environment;
- Young pets like to catch bites. Please pay attention to cable protection;
- The touch panel is tempered glass, and there is a risk of chipping when dropped. Place the purifier on a flat surface;
- Do not disassemble yourself;
- In the AWAY mode, please wait for the ozone to decompose before entering the room

10 / Warranty Terms

Within the period of warranty, if the product fails with no fault of user operations, it will be repaired at Petoneer's expense. The warranty will not cover product failure in examples below:

- Intentional damage to the product by the user or third party
- Failure to operate or maintain the product following the (QIG) Quick Installation Guide Instructions.
- Failure by natural wear and tear including but not limited to scratching, corrosion, oxidation and rusting.
- Failure by non-authorized repair of the product including but not limited to user's own or third-party repairing attempts or modifications.

www.petoneer.com

*All Pictures shown in the manual are for illustration purpose only. Actual product may vary due to product enhancement.